

VERSIONE:008

DEL:1996-07-11

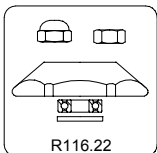

R116.22

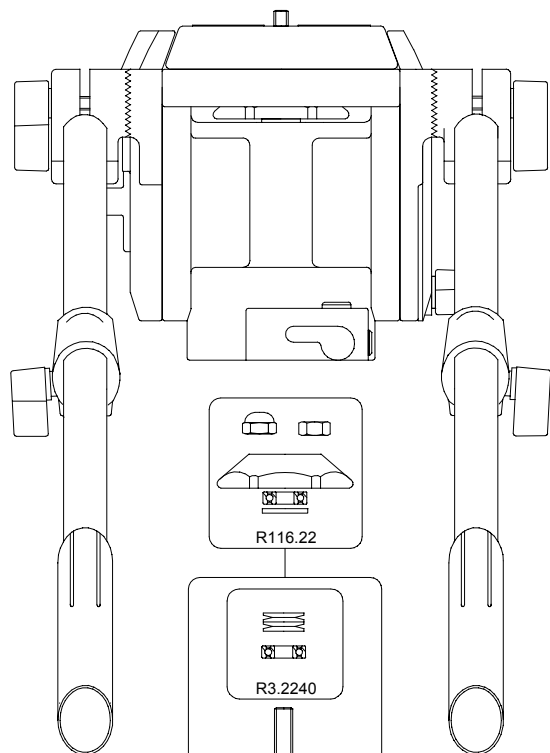
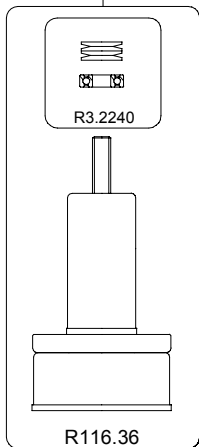

R116.36

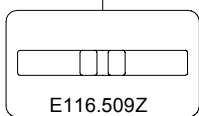

E116.509Z

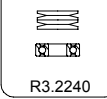

R3.2240

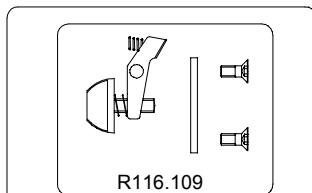

R116.109

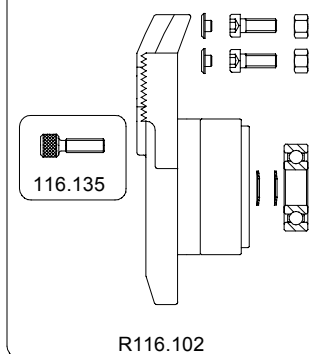

R116.102

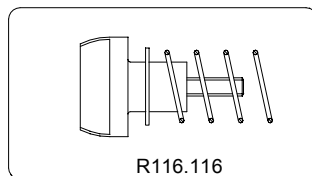

R116.116

FOR FLUID HEAD ORDER COD. R116.23

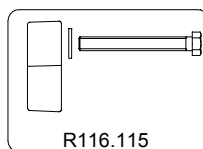

R116.115

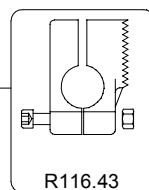

R116.43

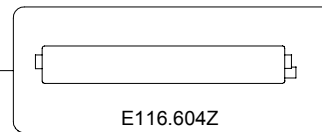

E116.604Z

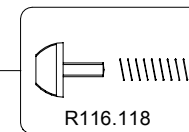

R116.118

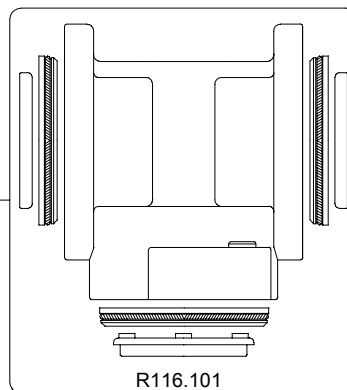

R116.101

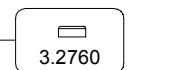

3.2760

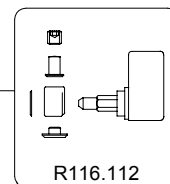

R116.112

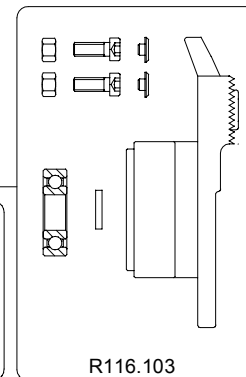

R116.103

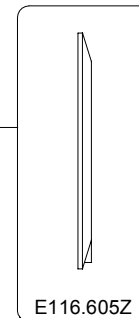

E116.605Z

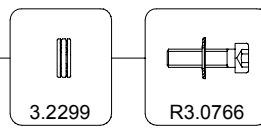

3.2299

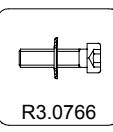

R3.0766

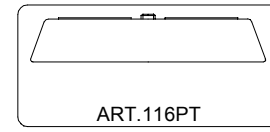

ART.116PT

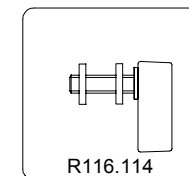

R116.114

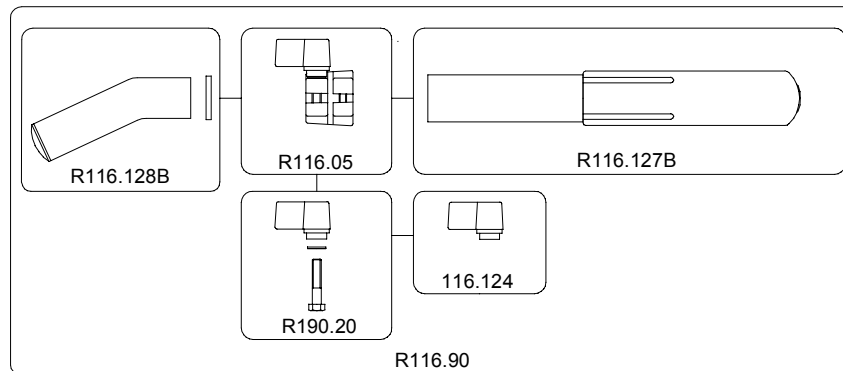

R116.90

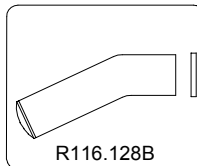

R116.128B

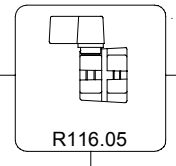

R116.05

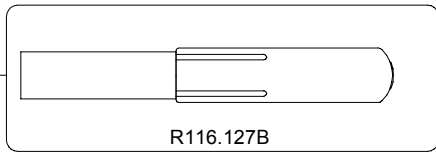

R116.127B

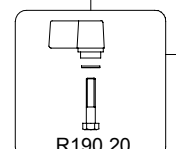

R190.20

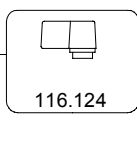

116.124

MANFROTTO NORO

ART.  
116MK3