

作成承認印

配布許可印

**Nikon****COOLPIX S3**

VAA60003 Silver

VAA60103 Red

VAA60203 White

VAA60323 Black

PARTS LIST

修理部品表

Nikon | NIKON CORPORATION
Tokyo, JapanCopyright © 2005 by Nikon Corporation.
All Rights Reserved.
無断転載を禁ず !!

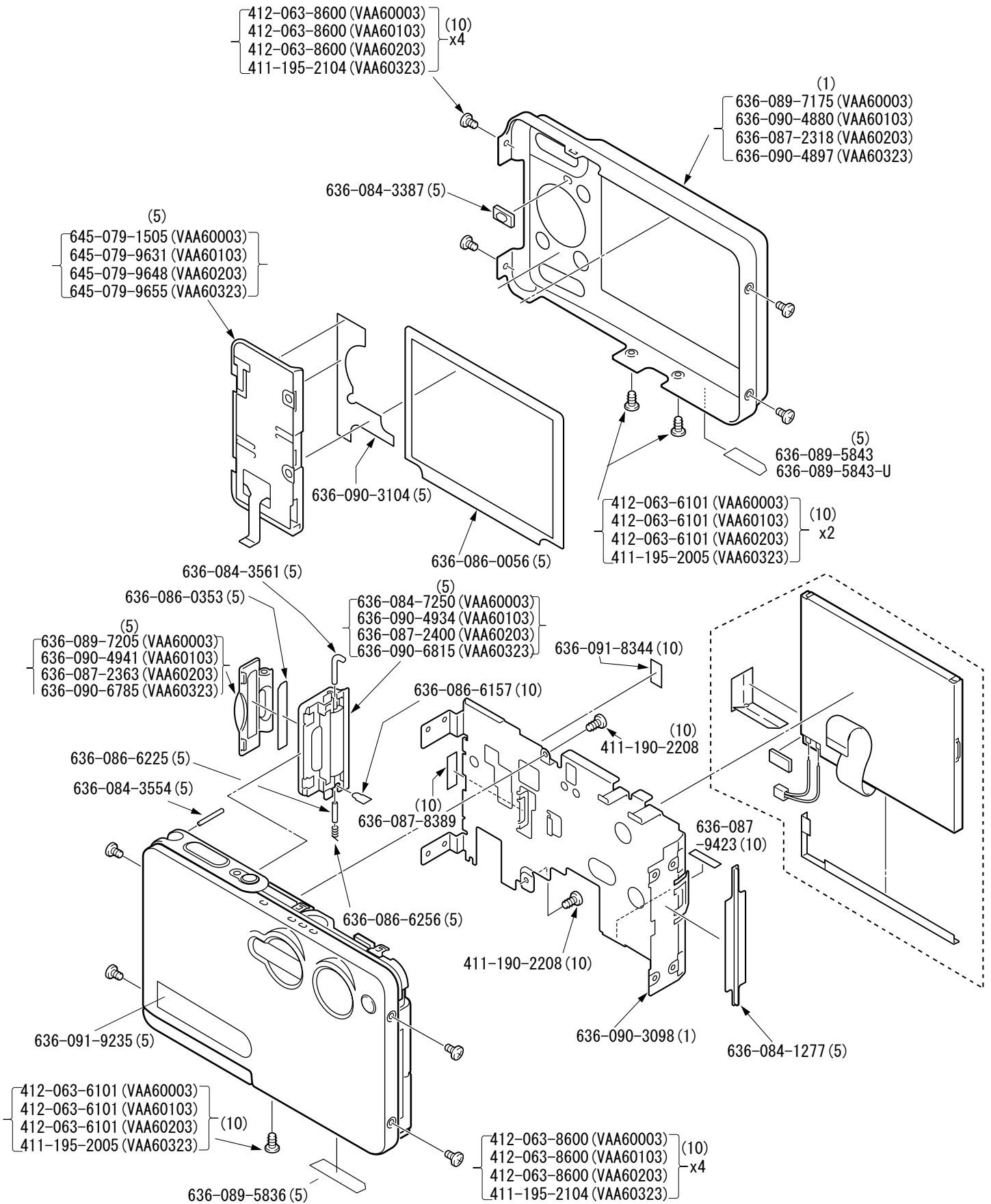

Fig. 1

Parts List

S3 Silver









VAA60003-R.3675.A

Part Number Part Code	Barcode (Part Code)	部品名 Part Name	Pcs./ Unit	fig No.	Main Assembly	Q'ty/ Order	Remarks
* 1S400-347 1S400-347		USB ソケット USB SOCKET	1	2	636-089-2187	5	
* 411-183-5902 411-183-5902		SCREW SCREW	1	2		10	
* 411-190-2208 411-190-2208		SCREW SCREW	8	1,2		10	
* 412-063-6101 412-063-6101		SCREW SCREW	3	1		10	
* 412-063-8600 412-063-8600		SCREW SCREW	8	1		10	
* 423-031-1707 423-031-1707		ヒューズ 32V 2A FUSE 32V 2A	3	2	636-089-2187	5	
* 423-031-1806 423-031-1806		ヒューズ 32V 2.5A FUSE 32V 2.5A	2	2	636-089-2187	5	
* 636-084-1192 636-084-1192		インナーカバー INNER COVER	1	2		5	
* 636-084-1277 636-084-1277		サイト飾り DECORATION SIDE	1	1		5	
* 636-084-1284 636-084-1284		バッテリーホルダー BATTERY HOLDER	1	2		5	
* 636-084-1314 636-084-1314		バッテリー ロックレバー BATTERY LOCK LEVER	1	2		5	
* 636-084-1352 636-084-1352		スタンド (SILVER) STAND (SILVER)	1	2		5	
* 636-084-1406 636-084-1406		スプリング SPRING	1	2		5	
* 636-084-3387 636-084-3387		LED ウィンドウ LED WINDOW	1	1		5	
* 636-084-3554 636-084-3554		ストラップ シャフト STRAP SHAFT	1	1		5	
* 636-084-3561 636-084-3561		カード シャフト CARD SHAFT	1	1		5	
* 636-084-3578 636-084-3578		シャフト (バッテリーカバー) SHAFT (BATT. COVER)	1	2		5	

Parts List

S3 Silver

VAA60003-R.3675.A

Part Number Part Code	Barcode (Part Code)	部品名 Part Name	Pcs./ Unit	fig No.	Main Assembly	Q'ty/ Order	Remarks
* 636-084-3622 636-084-3622		スプリング (バッテリーレバー) SPRING (BATT. LEVER)	1	2		5	
* 636-084-3646 636-084-3646		スプリング SPRING	1	2		5	
* 636-085-0057 636-085-0057		スピーカーホルダー SPEAKER HOLDER	1	2		5	
* 636-086-0025 636-086-0025		スペーサー (コンデンサー) SPACER (CONDENSER)	1	2	636-089-2187	5	
* 636-086-0049 636-086-0049		スペーサー SPACER	1	2		5	
* 636-086-0056 636-086-0056		スペーサー (モニター) SPACER (MONITOR)	1	1		5	
* 636-086-0353 636-086-0353		ラベル (カード) LABEL (CARD)	1	1		5	
* 636-086-0360 636-086-0360		ラベル (バッテリーカバー) LABEL (BATT. COVER)	1	2		10	
* 636-086-6157 636-086-6157		プレート PLATE	1	1		10	
* 636-086-6225 636-086-6225		シャフト SHAFT	1	1		5	
* 636-086-6256 636-086-6256		スプリング SPRING	1	1		5	
* 636-086-6393 636-086-6393		両面テープ ADHESIVE DOUBLE COATED TAPE	1	2		10	
* 636-086-6607 636-086-6607		スペーサー (CP1) SPACER (CP-1)	1	2		5	
* 636-086-6614 636-086-6614		スペーサー (レンズ) SPACER (LENS)	1	2		10	
* 636-086-6621 636-086-6621		シャフト SHAFT	1	2		5	
* 636-086-6850 636-086-6850		スペーサー SPACER	1	2		10	
* 636-086-6874 636-086-6874		スペーサー ((マイク)) SPACER (MIC)	1	2		10	

Parts List

S3 Silver

VAA60003-R.3675.A

Part Number Part Code	Barcode (Part Code)	部品名 Part Name	Pcs./ Unit	fig No.	Main Assembly	Q'ty/ Order	Remarks
* 636-086-6881 636-086-6881		スペーサー SPACER	1	2		10	
* 636-086-6898 636-086-6898		スペーサー (LED) SPACER (LED)	1	2		5	
* 636-087-5838 636-087-5838		シールドテープ SHIELD TAPE	1	2		10	
* 636-087-8389 636-087-8389		スペーサー SPACER	1	1		10	
* 636-087-9423 636-087-9423		スペーサー SPACER	1	1		10	
* 636-088-1013 636-088-1013		スペーサー (モーター) SPACER (MOTOR)	1	2		10	
* 636-088-1310 636-088-1310		スペーサー SPACER	2	2		10	
* 636-088-6797 636-088-6797		スプリング (イジェクト) SPRING (EJECT)	1	2		5	
636-089-2187 636-089-2187		メイン基板部組 CP-1 MAIN PCB UNIT CP-1	1	2		1	
636-089-2194 636-089-2194		LED基板部組 TB-1 LED PCB UNIT TB-1	1	2		5	
636-089-5362 636-089-5362		前カバー (SILVER) FRONT COVER (SILVER)	1	2		1	
636-089-5447 636-089-5447		フラッシュ飾りカバー FLASH DECORATION COVER	2	2		10	
636-089-5836 636-089-5836		規格シール LABEL RATING	1	1		5	
636-089-5836 636-089-5836		製品番号シール (J) LABEL SERIAL 2-	0-1	1		5	
636-089-5836-U 636-089-5836-U		製品番号シール (J) LABEL SERIAL 3-	0-1	1		5	
636-089-5843-E 636-089-5843-E		製品番号シール (J) EU LABEL SERIAL 4-	0-1	1		5	
636-089-5850 636-089-5850		ラベルポップ (U) LABEL POP (U)	0-1	1		5	

Parts List

S3 Silver





















VAA60003-R.3675.A

Part Number Part Code	Barcode (Part Code)	部品名 Part Name	Pcs./ Unit	fig No.	Main Assembly	Q'ty/ Order	Remarks
636-089-7175 636-089-7175		後カバー (SILVER) BACK COVER (SILVER)	1	1		1	
636-089-7199 636-089-7199		レンズカバー (SILVER) LENS COVER (SILVER)	1	2		5	
636-089-7205 636-089-7205		SDカードカバー (SILVER) SD CARD COVER (SILVER)	1	1		5	
636-089-7212 636-089-7212		バッテリーカバー (SILVER) BATTERY COVER (SILVER)	1	2		5	
636-089-7250 636-089-7250		カードホルダー (SILVER) CARD HOLDER (SILVER)	1	1		5	
636-090-3098 636-090-3098		モニターホルダー ユニット MONITOR HOLDER UNIT	1	1		1	
636-090-3104 636-090-3104		両面テープ ADHESIVE DOUBLE COATED TAPE	1	1		5	
636-091-5756 636-091-5756		レンズユニット LENS UNIT	1	2		1	
636-091-6227 636-091-6227		スペーサー SPACER	2	2		10	
636-091-8344 636-091-8344		スペーサー SPACER	1	1		10	
636-091-9235 636-091-9235		ラベルポップ (欧州 アジア) LABEL POP (EU.ASIA)	0-1	1		5	
636-092-3027 636-092-3027		フラッシュユニット FLASH UNIT	1	2		5	
* 645-064-7970 645-064-7970		SDカードソケット SD CARD SOCKET	1	2	636-089-2187	5	
* 645-073-0887 645-073-0887		マイクフォン MICROPHONE	1	2		5	
* 645-073-6063 645-073-6063		バリアモーターユニット BARRIER MOTOR UNIT	1	2		1	
* 645-073-6162 645-073-6162		コントロールトップユニット CONTROL TOP UNIT	1	2		5	
* 645-075-1547 645-075-1547		スピーカー SPEAKER	1	2		5	

Parts List

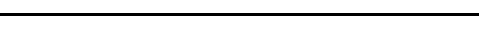
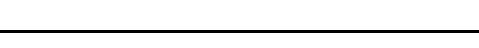
S3 Red

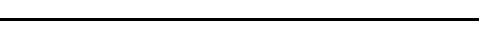



















VAA60103-R.3675.A

Part Number Part Code	Barcode (Part Code)	部品名 Part Name	Pcs./ Unit	fig No.	Main Assembly	Q'ty/ Order	Remarks
* 412-063-6101		SCREW	3	1		10	
412-063-6101		SCREW					
* 412-063-8600		SCREW	8	1		10	
412-063-8600		SCREW					
636-090-4811		レンズカバー (RED)	1	2		5	
636-090-4811		LENS COVER (RED)					
636-090-4842		バッテリーホルダー (RED)	1	2		5	
636-090-4842		BATTERY HOLDER (RED)					
636-090-4880		後カバー (RED)	1	1		1	
636-090-4880		BACK COVER (RED)					
636-090-4903		スタンド (RED)	1	2		5	
636-090-4903		STAND (RED)					
636-090-4927		バッテリーカバー (RED)	1	2		5	
636-090-4927		BATTERY COVER (RED)					
636-090-4934		カードホルダー (RED)	1	1		5	
636-090-4934		CARD HOLDER (RED)					
636-090-4941		SDカードカバー (RED)	1	1		5	
636-090-4941		SD CARD COVER (RED)					
636-090-4958		前カバー (RED)	1	2		1	
636-090-4958		FRONT COVER (RED)					
645-079-9631		コントロールバックユニット (RED)	1	1		5	
645-079-9631		CONTROL BACK UNIT (RED)					

Parts List

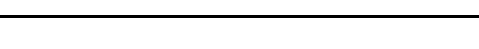
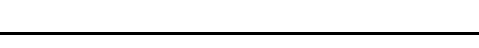
S3 White

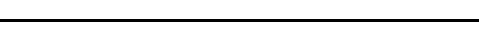



















VAA60203-R.3675.A

Part Number Part Code	Barcode (Part Code)	部品名 Part Name	Pcs./ Unit	fig No.	Main Assembly	Q'ty/ Order	Remarks
* 412-063-6101		SCREW	3	1		10	
412-063-6101		SCREW					
* 412-063-8600		SCREW	8	1		10	
412-063-8600		SCREW					
* 636-084-1352		スタンド (WHITE)	1	2		5	
636-084-1352		STAND (SILVER WHITE)					
* 636-087-2318		後カバー (WHITE)	1	1		1	
636-087-2318		BACK COVER (WHITE)					
* 636-087-2349		レンズカバー (WHITE)	1	2		5	
636-087-2349		LENS COVER (WHITE)					
* 636-087-2363		SDカードカバー (WHITE)	1	1		5	
636-087-2363		SD CARD COVER (WHITE)					
* 636-087-2387		バッテリーカバー (WHITE)	1	2		5	
636-087-2387		BATTERY COVER (WHITE)					
* 636-087-2400		カードホルダー (WHITE)	1	1		5	
636-087-2400		CARD HOLDER (WHITE)					
636-090-4859		バッテリーホルダー (WHITE)	1	2		5	
636-090-4859		BATTERY HOLDER (WHITE)					
636-090-4965		前カバー (WHITE)	1	2		1	
636-090-4965		FRONT COVER (WHITE)					
645-079-9648		コントロールバックユニット (WHITE)	1	1		5	
645-079-9648		CONTROL BACK UNIT (WHITE)					

Parts List

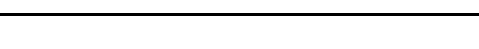
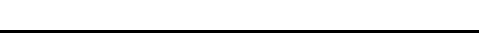
S3 Black

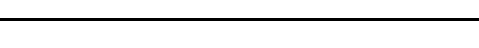
VAA60323-R.3675.A

Part Number Part Code	Barcode (Part Code)	部品名 Part Name	Pcs./ Unit	fig No.	Main Assembly	Q'ty/ Order	Remarks
* 411-195-2005		SCREW	3	1		10	
411-195-2005		SCREW					
* 411-195-2104		SCREW	8	1		10	
411-195-2104		SCREW					
636-090-4897		後カバー (BLACK)	1	1		1	
636-090-4897		BACK COVER (BLACK)					
636-090-6778		レンズカバー (BLACK)	1	2		5	
636-090-6778		LENS COVER (BLACK)					
636-090-6785		SDカードカバー (BLACK)	1	1		5	
636-090-6785		SD CARD COVER (BLACK)					
636-090-6792		バッテリーカバー (BLACK)	1	2		5	
636-090-6792		BATTERY COVER (BLACK)					
636-090-6815		カードホルダー (BLACK)	1	1		5	
636-090-6815		CARD HOLDER (BLACK)					
636-091-0430		前カバー (BLACK)	1	2		1	
636-091-0430		FRONT COVER (BLACK)					
636-091-0454		バッテリーホルダー (BLACK)	1	2		5	
636-091-0454		BATTERY HOLDER (BLACK)					
636-091-0478		スタンド (BLACK)	1	2		5	
636-091-0478		STAND (BLACK)					
645-079-9655		コントロールバックユニット (BLACK)	1	1		5	
645-079-9655		CONTROL BACK UNIT (BLACK)					